

**NRA Traffic Signs
Approvals Procedure**

Version 1.2

February 2008

TABLE OF CONTENTS

1	INTRODUCTION.....	1
1.1	GENERAL	1
1.2	ABBREVIATIONS / TERMINOLOGY	1
2	PROCEDURE	2
2.1	SUMMARY OF PHASES.....	2
2.2	PHASE A – SIGNING STRATEGY	2
2.3	PHASE B – DRAFT SIGN FACES & SIGN LOCATIONS.....	4
2.4	PHASE C – FINAL SIGN DESIGN	6
3	SUBMISSIONS FOR NRA APPROVALS	8

APPENDICES

APPENDIX A	Check Certificate A – Signing Strategy
APPENDIX B	Check Certificate B – Draft Sign Faces & Sign Locations
APPENDIX C	Check Certificate C – Final Sign Design
APPENDIX D	Sample Drawings

1 INTRODUCTION

1.1 GENERAL

The purpose of this document is to provide guidance to Local Authorities (LA) and their Designers on the Technical Approval procedure for directional road signs, including tourist signs. The National Roads Authority (NRA) requires that all proposed directional signs on National roads and sections of non-National roads included in NRA funded schemes are subject to Technical Approval by the NRA.

The objective of this Technical Approval procedure is to ensure, as far as reasonably practicable, that directional road signs are designed in accordance with the latest guidance for traffic sign design, and that a clear, consistent and efficient signing strategy is adopted on all National Road Schemes to assist in the management of traffic and to ensure the safe operation of the road network.

1.2 ABBREVIATIONS / TERMINOLOGY

LA - Local Authority (where possible, all liaison with respect to proposed directional road signs will be with the Local Authority's Senior Engineer responsible for the particular scheme or route. Consultation may also be required with Area Engineers with respect to identifying/agreeing locations for proposed signs etc).

NRA - National Roads Authority (typically, all liaison with respect to proposed directional road signs will be with the NRA's Sign Approvals Section. However the NRA Senior Project Manager and/or Engineering Inspector for the particular jurisdiction may also be involved where necessary).

OS – Ordnance Survey.

SD - Sign Designer (individual responsible for the design/checking of proposed directional road signs within a design organisation or design office, who will be dealing with all correspondence, liaison and consultation).

TSM - Traffic Signs Manual (including any supplementary sign design guidance).

PDF – Portable Document Format (Adobe)

DWF - Design Web Format (Autodesk)

2 PROCEDURE

The procedure for the design, check and approval of proposed directional road signs for National Roads and sections of Non-National Roads included in NRA funded schemes is outlined in the following paragraphs.

2.1 SUMMARY OF PHASES

The NRA Traffic Sign Approval procedure consists of three phases:

Phase A	Signing Strategy
Phase B	Draft Sign Faces and Sign Locations
Phase C	Final Sign Design

For new build schemes and large-scale sign refurbishment / re-signing proposals etc, all three phases will apply. For small-scale directional sign erection or replacement being carried out by a LA, only Phase C applies.

2.2 PHASE A – SIGNING STRATEGY

The main objective of this phase is to produce, in agreement with the NRA and with input from the LA, an overall signing strategy for the scheme or route.

2.2.1 SD produces the following:-

(i) Overall Route-Destination Map

- Single large-scale drawing showing entire scheme/route, maximum A1 sheet size.
- Based on OS mapping or other mapping where appropriate.
- Indicates proposed scheme/route.
- All **terminals** and **intermediate terminals** should be highlighted along with all other **significant destinations**, **off-route destinations** and **major tourist attractions** as identified in consultation with Fáilte Ireland and which qualify for directional signage under the NRA's Tourist Signs Policy document.
- A colour hierarchy should be used to highlight all of the above destinations in order of importance.

Note: the inclusion of destinations on such a drawing does not infer that they will be included on the proposed signage.

(ii) Signing Strategy Drawings

- Drawings of the full scheme/route or of sections of the scheme/route, maximum A1 sheet size.
- Based on topographical mapping, OS discovery series mapping or other mapping as appropriate.

- Indicates proposed scheme/route, including all junctions/interchanges.
- Indicates all intersecting roads and corresponding route/road numbers.
- For each junction, **all destinations** considered applicable should be clearly indicated for each direction. These should include **terminal** and **intermediate terminals**, **other significant destinations**, **off-route destinations** and **major tourist attractions** which qualify for directional signage under the NRA's Tourist Signs Policy.
- The strategy should also indicate on which signs each of these destinations are to be shown (e.g. on advanced directional or confirmatory signs). One method of doing this is to use a 'dots' system, an example of which is given in Appendix D.
- The drawing should specify if the destinations are mandatory or optional with regard to the requirements of the Traffic Sign Manual. (Refer to Appendix D for sample Signing Strategy drawing).

2.2.2 SD sends **2 sets** of the Overall Route-Destination Map and Signing Strategy Drawings to the NRA for review.

2.2.3 SD to liaise/meet with NRA to agree the signing strategy:-

- Agree main terminal and intermediate terminal destinations and other significant destinations and tourist attractions to be signed.
- Agree route numbers to be included.
- Ensure that proposed signing strategy is consistent with NRA's national network signing strategy.

2.2.4 SD revises signing strategy to accommodate the NRA's input and sends **2 sets** of the Overall Route-Destination Map and the Signing Strategy Drawings to the relevant LA for review.

2.2.5 SD liaises/meets with LA to agree signing strategy:-

- Agree destinations including tourist destinations to be signed.
- Agree route numbers to be included.
- Where necessary for new sections of road, or for the reclassification of sections of existing road, an application for a new route classification from the NRA may be required (refer to NRA Circular on Route Classification).

2.2.6 If any changes to the signing strategy are considered necessary following liaison with the LA, the SD reverts to the NRA to discuss the LA's requirements and to agree the final Signing Strategy.

2.2.7 SD revises and checks the final Overall Route-Destination Map and Signing Strategy Drawings as per 2.2.1 above, completes Check Certificate A including the schedule of signing strategy drawings (see Appendix A), and then sends **3 sets** to the LA for checking. When checked, the LA signs Check Certificate A and submits **2 sets** to the NRA for approval.

2.2.8 On final approval, the NRA signs Check Certificate A and issues a copy of the completed Certificate to the LA and the SD. (If approval is not granted, NRA sends comments to the LA, who in turn forwards them to the SD. Alternatively, a meeting to discuss the Phase A submission may be required).

2.3 PHASE B – DRAFT SIGN FACES & SIGN LOCATIONS

In this phase the SD produces draft hand-drawn sign face sketches and sign location drawings based on the destinations agreed in the signing strategy. The purpose of this phase is for the SD to agree the sign type, sign face layout and relevant details with the NRA prior to full digital design.

2.3.1 SD produces the following:-

(i) Draft Sign Face Sketches:

- A4 hand drawn pencil sketches of sign faces, each with a unique sign face reference number, designed to the basic parameters of the Traffic Signs Manual.
- Indicates type and layout of sign (e.g. flag, stack, map, gantry etc.) Note: precise dimensions of the sign face designs including clearances to text etc are not of concern at this point – see sample in Appendix D.
- Indicates destinations and route numbers (including local road numbers as appropriate) as agreed in Phase A.
- Indicates junction numbers where applicable (refer to NRA for approved junction numbering schemes).
- Indicates symbols etc where appropriate.
- (Note: SD should give careful consideration to the amount of information provided on sign faces in order to avoid information overload and driver confusion).
- Where not supported by normal upright posts, the type of support should be indicated (e.g. cantilever, gantry, butterfly etc.)
- Sketches should indicate x-heights, panels, patches, text and background colours, material (Class/Type), mounting heights, etc.
- A schedule of the proposed Traffic Signs should be prepared for inclusion in Check Certificate B (See Appendix B).
- Where non-standard designs have been proposed, SD to include justification in Schedule of Signs.

(ii) Sign Location Drawings:

- Indicating approximate location of each proposed directional sign for the scheme/route (see Appendix D for sample sign locations drawing).

2.3.2 SD sends 2 sets of the Sign Face Sketches and Sign Location Drawings to the NRA* for review.

* Note: Depending on the scheme, the LA may request to be consulted on this phase.

2.3.3 It may prove useful for the SD to meet with the LA, including the relevant Area Engineer(s) as appropriate, for feedback and to discuss locations, available space, setbacks and mounting heights for all signs (it may be preferable to hold such meetings on site).

2.3.4 SD liaises/meets with the NRA to agree sign face sketches and sign locations.

- 2.3.5 SD revises sketches and drawings incorporating the NRA's comments. SD then completes and signs Check Certificate B, and sends **2 sets** of the Sign Face Sketches, Sign Location Drawings and Check Certificate B directly to the NRA for Approval.
- 2.3.6 On approval, the NRA signs Check Certificate B and issues a copy of the completed Certificate to the LA and the SD. (If approval is not granted, NRA sends comments to the SD. Alternatively, a meeting to discuss the Phase B submission may be required).

Note:

Where the LA has been consulted on Phase B, the SD should forward **1 set** of the above, including Check Certificate B for signing.

2.4 PHASE C – FINAL SIGN DESIGN

In this phase the SD produces the final detailed design of the proposed directional sign faces and associated post and foundations for the scheme/route, checking that all the information is provided and correct before issuing these to the LA for checking and to the NRA for final approval.

(Note: For small-scale directional sign erection or replacement being carried out by a LA, references to 'Signing Strategy' may not apply).

2.4.1 SD designs sign faces using AutoSign (Eire) software in accordance with TSM and latest traffic sign design guidance. SD also designs post and foundations:-

- A4 Sign Face drawings to be produced, including all sign face details, post and foundation details, and given unique reference number (Refer to Appendix D for sample Sign Face drawing).
- Checks location of each sign.
- Checks all destinations and route numbers, including sign and panel colours etc.
- Checks spelling of both English and Irish versions of destinations (where necessary, Irish translations may be required – these should be sought through the LA from the Irish Place Names Commission).
- Checks that the use of symbols is correct.
- Checks setbacks, mounting heights of all signs.
- Checks post / foundation details (with due regard to the impact of sign supports on road safety).
- Checks if signs can fit within the space available. Particular attention should be paid to signs located on splitter islands (site visit may be required).
- Checks x-heights for all signs.
- Checks sign material (Class/Type) for all signs.
- Where non-standard designs have been proposed, SD includes justification in the Certificate C Schedule of Signs.

2.4.2 SD completes Check Certificate C, and sends **2 sets** of the *Designed Sign Face Drawings*, *Sign Location Drawings* (from Phase B), and *Signing Strategy Drawings* (from Phase A) to the LA for review.

2.4.3 LA reviews *Designed Sign Face Drawings* with reference to the *Sign Location* and *Signing Strategy Drawings* making comments on the following if necessary:-

- Location of each sign.
- Destinations and route numbers (note: particular care should be taken with local road numbers)
- Spelling of both English and Irish versions of destinations.
- Setbacks and mounting heights of all signs.
- If signs can fit within the space available.
- Sign material (Class/Type) for all signs.

- 2.4.4 If changes are required, LA returns a marked up set of the *Designed Sign Face Drawings* to the SD for amending. SD revises drawings incorporating the LA's comments. SD then sends Check Certificate C and **3 sets** of the *Designed Sign Face Drawings*, *Sign Location Drawings* and *Signing Strategy Drawings* and Check Certificate C to the LA.
- 2.4.5 Once the *Designed Sign Face Drawings* and *Sign Location Drawings* are fully agreed and checked, the LA signs Check Certificate C and submits the certificate along with **2 sets** of the final *Designed Sign Face Drawings*, *Signing Strategy Drawings* and *Sign Location Drawings* to the NRA for Approval.
- 2.4.6 On approval, the NRA signs Check Certificate C and issues a copy of the completed Certificate to the LA and the SD. (If approval is not granted, NRA sends comments to the LA, who in turn forwards them to the SD. Alternatively, a meeting to discuss the Phase C submission may be required).

Note:

Only versions of the Sign Face drawings which have received full Phase C approval in the form of a completed Check Certificate C from the NRA may be included in contract documentation and/or passed to a Contractor for manufacture and installation.

3 SUBMISSIONS FOR NRA APPROVALS

NRA Approvals shall entail the acceptance of the completed Check Certificates and drawings etc. by the NRA. Approval shall only be granted by the NRA if all the necessary information is submitted with the completed Check Certificates.

Note: Where the LA wishes to replace a damaged sign on an existing signage scheme the first two phases A and B can be omitted and the procedure set out in Phase C should be followed. Such signs may be procured using the NRA's sign refurbishment contracts.

3.1 APPROVAL APPLICATIONS

Traffic Signs Approvals applications should be made to:

**Signs Approvals Section
Networks Operations
National Roads Authority
St. Martins House
Waterloo Road
Dublin 4
Phone: 01 6602511
Fax: 01 6624887
Email: signsapprovals@nra.ie**

Applications received electronically (in PDF or DWF format only) will be accepted for processing, however processing cannot be completed until a hard copy (including originals of signed Certificates) is received to the above address. Where PDF or DWF files are used, ensure that drawings are contained within one file rather than individual files for each drawing. Before sending any large e-mails please ensure that a phone call is placed to ensure that the e-mail can be printed/moved immediately in order to avoid clogging the e-mail system for other applications.

Allow a **minimum** of 2 weeks from receipt of applications to the NRA Signs Approvals Section to the notification of Approval. This time period will take longer for larger schemes with a larger number of signs. Applications should be submitted to the NRA as soon as possible to avoid delays.

If a scheme with a large number of signs is to be submitted, then advance notice should be given to the NRA Signs Approvals Section in order that the application can be processed as efficiently as possible.

3.2 CHECKLIST OF APPLICATION DOCUMENTS

The following should accompany a Traffic Signs Approval application to the NRA.

Phase A Approval – Signing Strategy

- Overall Route-Destination Map (max size A1) – 2 sets
- Signing Strategy Drawings (max size A1) – 2 sets
- Completed Check Certificate A signed by SD and LA (including schedule of drawings)

Phase B Approval – Draft Sign Faces and Sign Locations

- Draft Sign Face Sketches (A4 hand-drawn) – 2 sets
- Sign Location Drawings (max size A1) – 2 sets
- Signing Strategy Drawings (max size A1) from Phase A – 2 sets
- Completed Check Certificate B signed by SD (and LA where consulted) including schedule of drawings

Phase C Approval – Final Sign Design

- Designed Sign Face Drawings - prepared using AutoSign (Eire) (size A4) – 2 sets
- Sign Location Drawings (max size A1) from Phase B – 2 sets
- Signing Strategy Drawings (max size A1) from Phase A – 2 sets
- Completed Check Certificate C signed by SD and LA (including schedule of drawings)

(Note: Editable versions of the check certificates are available on the NRA's website; www.nra.ie)

APPENDIX A

CHECK CERTIFICATE A

SIGNING STRATEGY

CHECK CERTIFICATE A – SIGNING STRATEGY

A.1 SCHEME DETAILS

Scheme Name: _____

Type Of Contract: _____

Client (Local Authority/Road Authority): _____

Client Address: _____

Client Contact (to whom the response will issue – name and address):

Sign Designer Contact: _____

Address: _____

NRA Scheme Inspector: _____

Key Scheme Future Dates:

Release Of Tender Documents	
Scheme Construction Start	
Scheme Construction Finish	
Other (please specify):	

A.2 DESIGNERS CERTIFICATION

I hereby certify to the National Roads Authority that the Signing Strategy drawings as listed on pages ___ to ___ of the attached ‘*Schedule of Signing Strategy Drawings*’ included with this Check Certificate A, have been designed and checked.

Designed By: Name: _____
 Position: _____
 Organisation: _____
 Office: _____
 Signed: _____
 Date: _____

A.3 LOCAL AUTHORITY CHECK

I hereby certify to the National Roads Authority that the Signing Strategy drawings as listed on pages ___ to ___ of the attached ‘*Schedule of Signing Strategy Drawings*’ included with this Check Certificate A, have been checked.

LA Check By: Name: _____
 Position: _____
 Local Authority: _____
 Office: _____
 Signed: _____
 Date: _____

A.4 NRA APPROVAL*

NRA Approval By*: Name: _____
 Position: _____
 Office: _____
 Signed: _____
 Date: _____

***NOTE: NRA Approval can only be made by the NRA Signs Approvals Section**

APPENDIX B

CHECK CERTIFICATE B

DRAFT SIGN FACES & SIGN LOCATION DRAWINGS

CHECK CERTIFICATE B – DRAFT SIGN FACES & SIGN LOCATIONS

B.1 SCHEME DETAILS

Scheme Name: _____

Type Of Contract: _____

Client (Local Authority/Road Authority): _____

Client Address: _____

Client Contact (to whom the response will issue – name and address):

Sign Designer Contact: _____

Address: _____

NRA Scheme Inspector: _____

Key Scheme Future Dates:

Release Of Tender Documents	
Scheme Construction Start	
Scheme Construction Finish	
Other (please specify):	

B.2 DESIGNERS CERTIFICATION

I hereby certify to the National Roads Authority that the drawings as listed on pages ____ to ____ of the attached '*Schedule of Draft Sign Face Drawings and Sign Location Drawings*' included with this Check Certificate B, have been designed and checked.

Designed By: Name: _____
 Position: _____
 Organisation: _____
 Office: _____
 Signed: _____
 Date: _____

B.3 LOCAL AUTHORITY CONSULTATION (where requested by LA)

I hereby certify to the National Roads Authority that we have been consulted on the development of the draft sign faces and sign locations, the drawings for which are listed on pages ____ to ____ of the attached '*Schedule of Draft Sign Face Sketches and Sign Location Drawings*' included with this Check Certificate B.

LA Consultation By: Name: _____
 Position: _____
 Local Authority: _____
 Office: _____
 Signed: _____
 Date: _____

B.4 NRA APPROVAL*

NRA Approval By*: Name: _____
 Position: _____
 Office: _____
 Signed: _____
 Date: _____

***NOTE: NRA Approval can only be made by the NRA Signs Approvals Section.**

APPENDIX C

CHECK CERTIFICATE C

FINAL SIGN DESIGN

CHECK CERTIFICATE C – FINAL SIGN DESIGN

C.1 SCHEME DETAILS

Scheme Name: _____

Type Of Contract: _____

Client (Local Authority/Road Authority): _____

Client Address: _____

Client Contact (to whom the response will issue – name and address):

Sign Designer Contact: _____

Address: _____

NRA Scheme Inspector: _____

Key Scheme Future Dates:

Release Of Tender Documents	
Scheme Construction Start	
Scheme Construction Finish	
Other (please specify):	

C.2 DESIGNERS CERTIFICATION

I hereby certify to the National Roads Authority that the drawings as listed on pages ____ to ____ of the attached '*Schedule of Designed Sign Face Drawings*' included with this Check Certificate C, have been designed and checked.

Designed By: Name: _____

 Position: _____

 Organisation: _____

 Office: _____

 Signed: _____

 Date: _____

C.3 LOCAL AUTHORITY CHECK

I hereby certify to the National Roads Authority that the drawings as listed on pages ____ to ____ of the attached '*Schedule of Designed Sign Face Drawings*' included with this Check Certificate C, have been checked.

LA Check By: Name: _____

 Position: _____

 Local Authority: _____

 Office: _____

 Signed: _____

 Date: _____

C.4 NRA APPROVAL*

NRA Approval By*: Name: _____

 Position: _____

 Office: _____

 Signed: _____

 Date: _____

***NOTE: NRA Approval can only be made by the NRA Signs Approvals Section.**

APPENDIX D

SAMPLE DRAWINGS

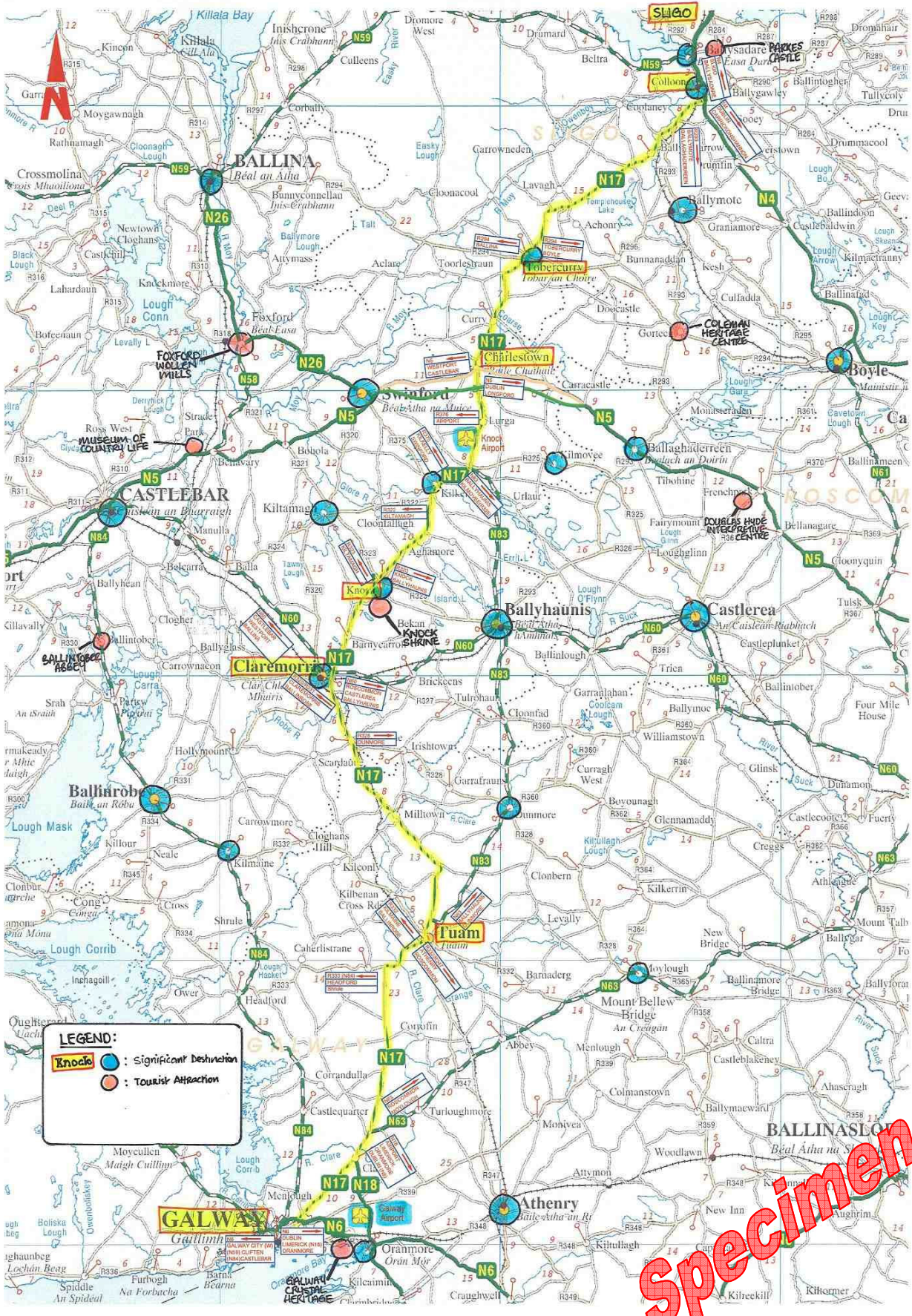

Overall Route - Destination Map (Phase A)

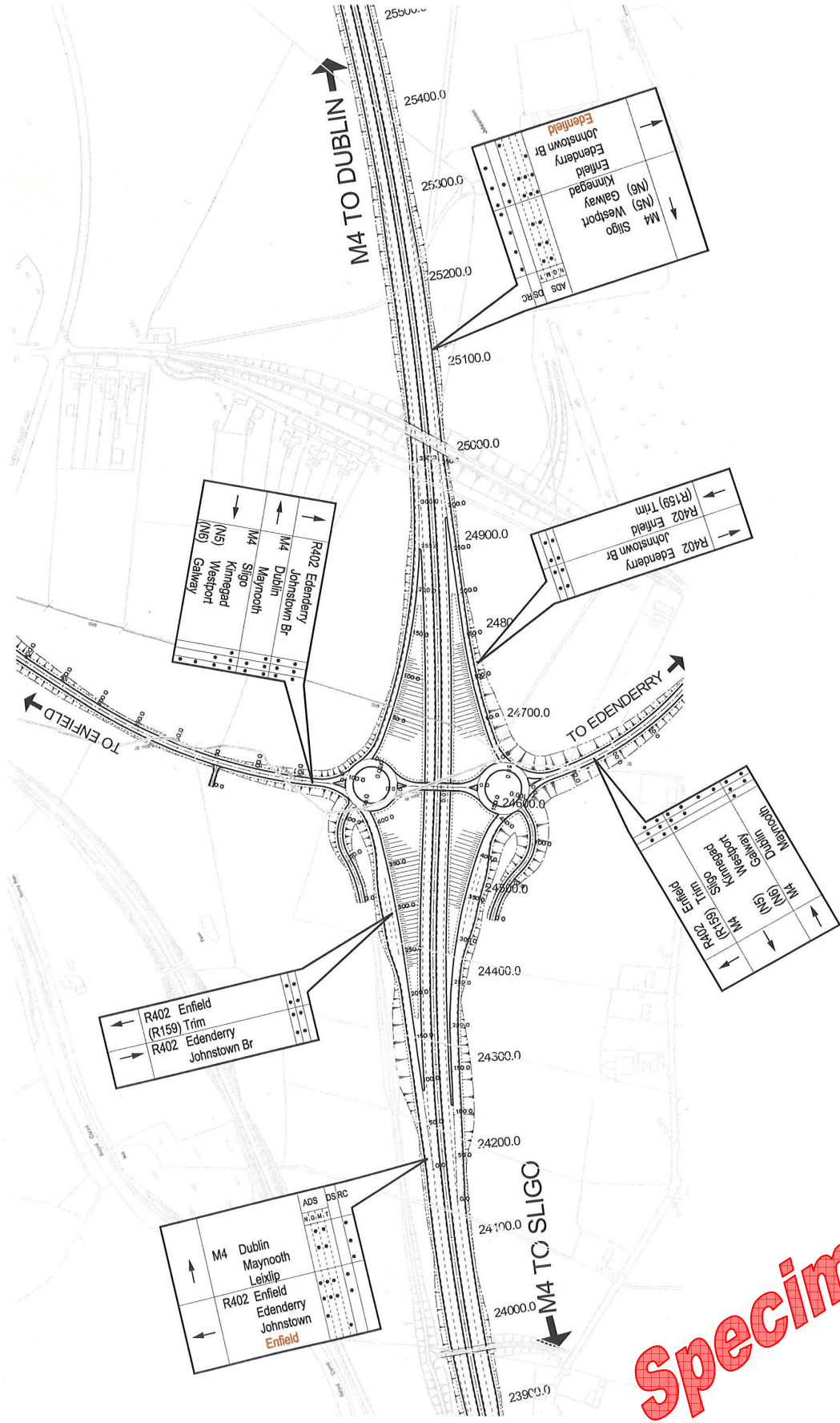

Specimen

Signing Strategy Drawing (Phase A)

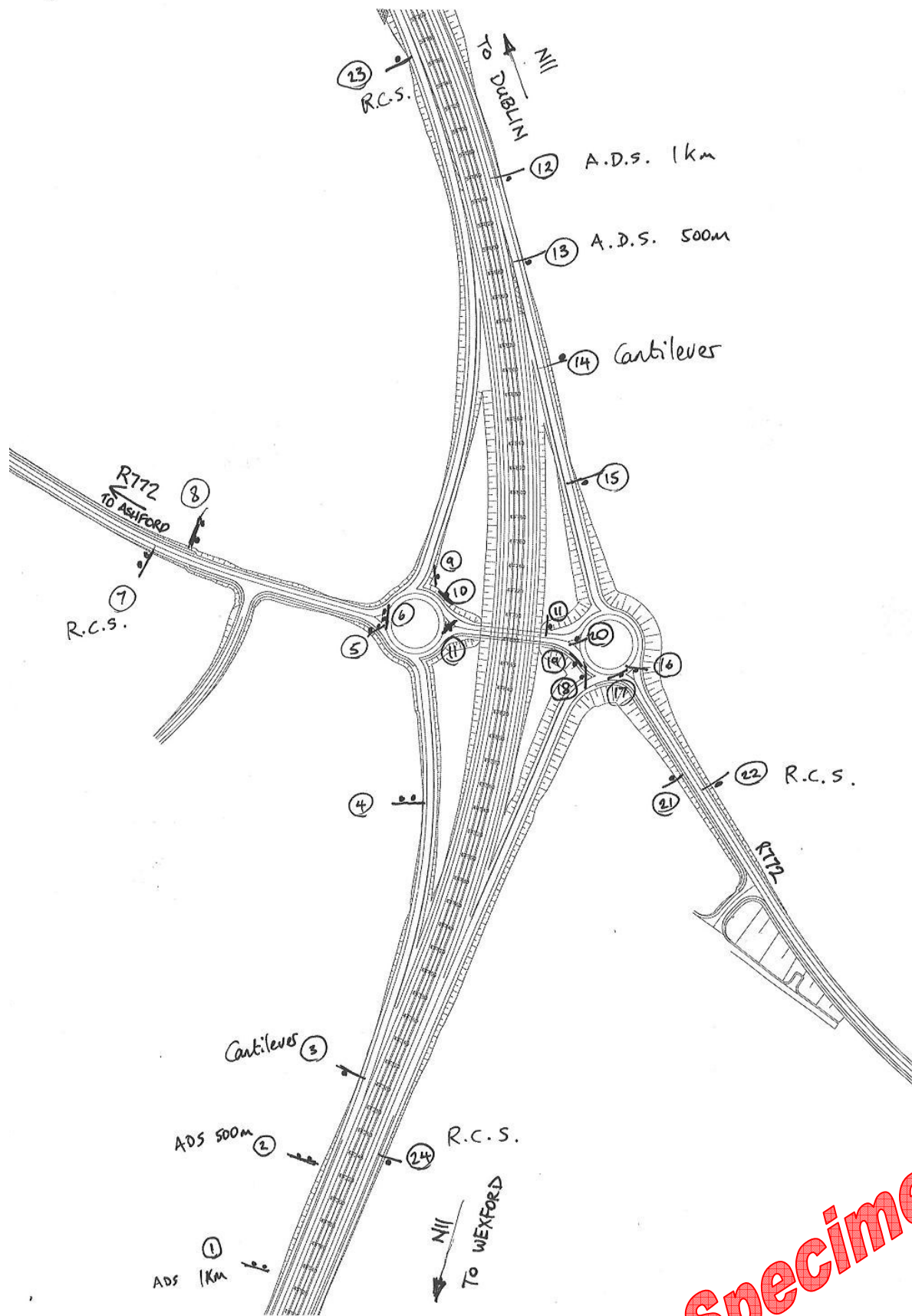

Specimen

Sign Location Drawing (Phase B)

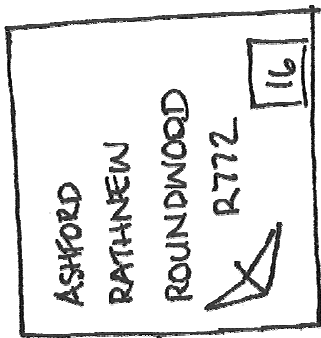

3

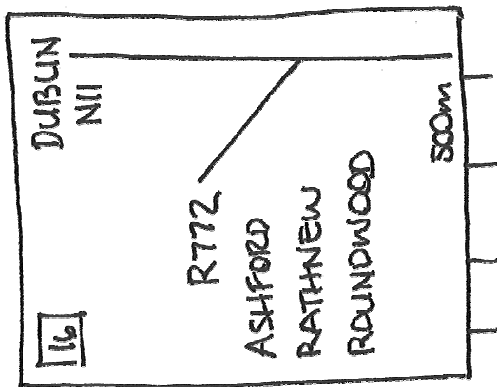

2

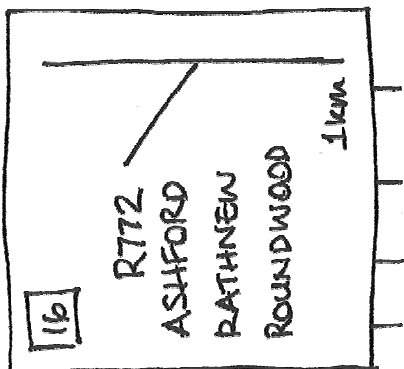

1

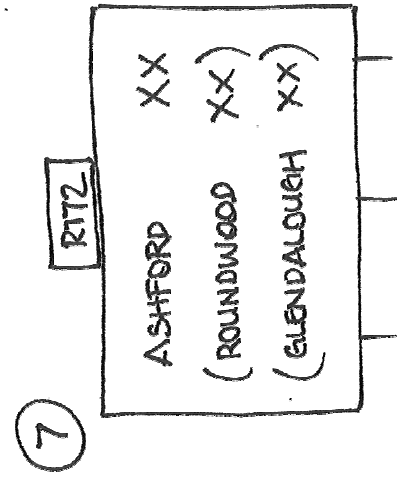

7

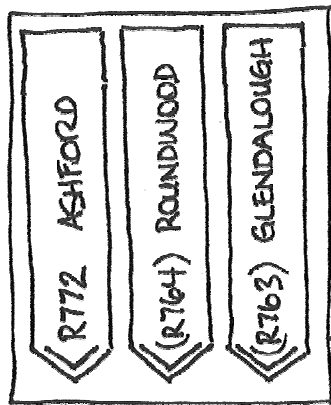

5

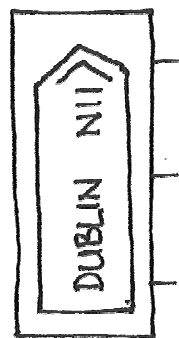

6

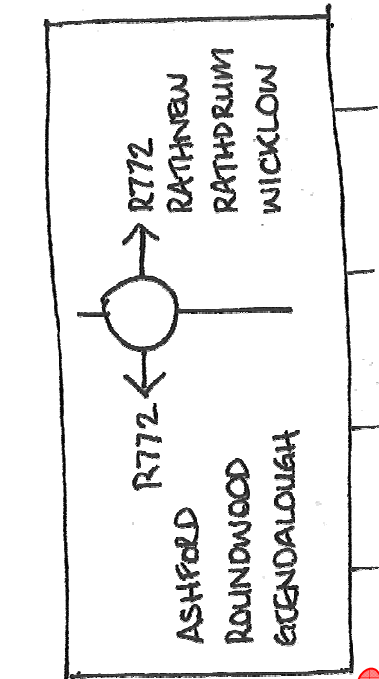

4

Specimen

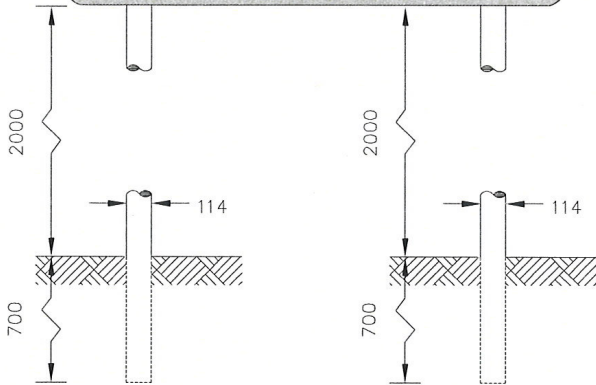

Scheme Ref.		
Sign Reference	01/07a	'x'-height 80
Letter colour	WHITE	SIGN FACE
Background	GREEN	Width 1480mm
Border	WHITE	Height 480mm
Material	Class 1	Area 0.71sq.m
NOTE Edge of sign must be at least 750 from edge of carriageway		

Scheme Ref.		
Sign Reference	01/07	'x'-height 80
Letter colour	N\A	SIGN FACE
Background	GREY	Width 1595mm
Border	N\A	Height 1690mm
Material	Class 1	Area 2.70sq.m
NOTE Edge of sign must be at least 750 from edge of carriageway		

POST(S) & FOUNDATIONS			
Mounting Height	2000mm	Bases	Combined
Number	2	Base Width	1800mm
Size	114.3x5CHS	Base Length	1400mm
Length	4390mm	Base Depth	700mm
Centres	1200mm	Base Vol. o/a	1.76 m3
Illumination	No	Earth Cover	0mm

Note :

- * Apply 80% condensing factor
- + Apply 90% condensing factor

Specimen